

Schema Schemat_JPK_PKPIR(2)_v1-0.xsd

schema location:

attributeFormDefault: **unqualified**
 elementFormDefault: **qualified**
 targetNamespace: **http://jpk.mf.gov.pl/wzor/2016/10/26/10262/**

Elements	Complex types	Simple types
JPK	TAdresJPK TNaglowek	TCelZlozenia TKodFormularza TKwotowy TNaturalnyJPK TZnakowyJPK

element JPK

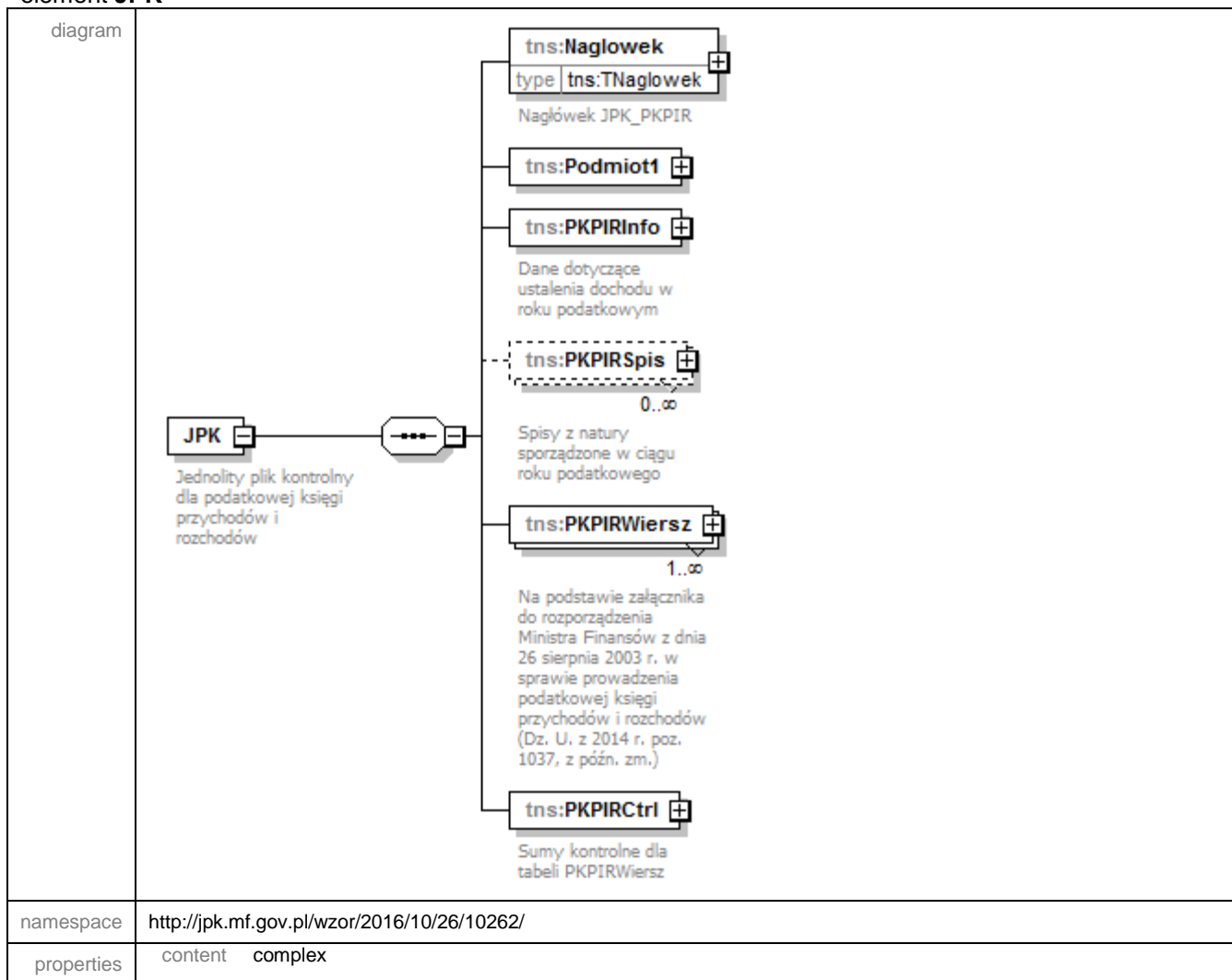

children	tns:Naglowek tns:Podmiot1 tns:PKPIRInfo tns:PKPIRSpis tns:PKPIRWiersz tns:PKPIRCtrl
annotation	documentation Jednolity plik kontrolny dla podatkowej księgi przychodów i rozchodów
source	<pre> <xsd:element name="JPK"> <xsd:annotation> <xsd:documentation>Jednolity plik kontrolny dla podatkowej księgi przychodów i rozchodów</xsd:documentation> </xsd:annotation> <xsd:complexType> <xsd:sequence> <xsd:element name="Naglowek" type="tns:TNaglowek"> <xsd:annotation> <xsd:documentation>Nagłówek JPK_PKPIR</xsd:documentation> </xsd:annotation> </xsd:element> <xsd:element name="Podmiot1"> <xsd:complexType> <xsd:sequence> <xsd:element name="IdentyfikatorPodmiotu" type="etd:TIdentyfikatorOsobyNiefizycznej"> <xsd:annotation> <xsd:documentation>Dane identyfikujące podmiot</xsd:documentation> </xsd:annotation> </xsd:element> <xsd:element name="AdresPodmiotu" type="tns:TAdresJPK"> <xsd:annotation> <xsd:documentation>Adres podmiotu</xsd:documentation> </xsd:annotation> </xsd:element> </xsd:sequence> </xsd:complexType> </xsd:element> <xsd:element name="PKPIRInfo"> <xsd:annotation> <xsd:documentation>Dane dotyczące ustalenia dochodu w roku podatkowym</xsd:documentation> </xsd:annotation> <xsd:complexType> <xsd:sequence> <xsd:element name="P_1" type="tns:TKwotowy"> <xsd:annotation> <xsd:documentation>Wartość spisu z natury na początek roku podatkowego</xsd:documentation> </xsd:annotation> </xsd:element> <xsd:element name="P_2" type="tns:TKwotowy"> <xsd:annotation> <xsd:documentation>Wartość spisu z natury na koniec roku podatkowego</xsd:documentation> </xsd:annotation> </xsd:element> <xsd:element name="P_3" type="tns:TKwotowy"> <xsd:annotation> <xsd:documentation>Razem koszty uzyskania przychodu, wg objaśnień do podatkowej księgi przychodów i rozchodów</xsd:documentation> </xsd:annotation> </xsd:element> </xsd:sequence> </xsd:complexType> </xsd:element> </xsd:sequence> </xsd:complexType> </xsd:element> </pre>

```

</xsd:annotation>
</xsd:element>
<xsd:element name="P_4" type="tns:TKwotowy">
  <xsd:annotation>
    <xsd:documentation>Dochód osiągnięty w roku podatkowym, wg objaśnień do
    podatkowej księgi przychodów i rozchodów</xsd:documentation>
  </xsd:annotation>
</xsd:element>
</xsd:sequence>
</xsd:complexType>
</xsd:element>
<xsd:element name="PKPIRSpis" minOccurs="0" maxOccurs="unbounded">
  <xsd:annotation>
    <xsd:documentation>Spisy z natury sporządzone w ciągu roku
    podatkowego</xsd:documentation>
  </xsd:annotation>
  <xsd:complexType>
    <xsd:sequence minOccurs="0">
      <xsd:element name="P_5A" type="etd:TData">
        <xsd:annotation>
          <xsd:documentation>Data spisu z natury sporządzonego w ciągu roku
          podatkowego</xsd:documentation>
        </xsd:annotation>
      </xsd:element>
      <xsd:element name="P_5B" type="tns:TKwotowy">
        <xsd:annotation>
          <xsd:documentation>Wartość spisu z natury sporządzonego w ciągu roku
          podatkowego</xsd:documentation>
        </xsd:annotation>
      </xsd:element>
    </xsd:sequence>
    <xsd:attribute name="typ" use="required" fixed="G"/>
  </xsd:complexType>
</xsd:element>
<xsd:element name="PKPIRWiersz" maxOccurs="unbounded">
  <xsd:annotation>
    <xsd:documentation>Na podstawie załącznika do rozporządzenia Ministra Finansów z
    dnia 26 sierpnia 2003 r. w sprawie prowadzenia podatkowej księgi przychodów i rozchodów (Dz. U.
    z 2014 r. poz. 1037, z późn. zm.)</xsd:documentation>
  </xsd:annotation>
  <xsd:complexType>
    <xsd:sequence>
      <xsd:element name="K_1" type="tns:TNaturalnyJPK">
        <xsd:annotation>
          <xsd:documentation>Lp.</xsd:documentation>
        </xsd:annotation>
      </xsd:element>
      <xsd:element name="K_2" type="etd:TData">
        <xsd:annotation>
          <xsd:documentation>Data zdarzenia gospodarczego</xsd:documentation>
        </xsd:annotation>
      </xsd:element>
      <xsd:element name="K_3" type="tns:TZnakowyJPK">
        <xsd:annotation>
          <xsd:documentation>Nr dowodu księgowego</xsd:documentation>
        </xsd:annotation>
      </xsd:element>
    </xsd:sequence>
  </xsd:complexType>

```

```

</xsd:element>
<xsd:element name="K_4" type="tns:TZnakowyJPK">
  <xsd:annotation>
    <xsd:documentation>Kontrahent - imię i nazwisko (firma)</xsd:documentation>
  </xsd:annotation>
</xsd:element>
<xsd:element name="K_5" type="tns:TZnakowyJPK">
  <xsd:annotation>
    <xsd:documentation>Kontrahent- adres</xsd:documentation>
  </xsd:annotation>
</xsd:element>
<xsd:element name="K_6" type="tns:TZnakowyJPK">
  <xsd:annotation>
    <xsd:documentation>Opis zdarzenia gospodarczego</xsd:documentation>
  </xsd:annotation>
</xsd:element>
<xsd:element name="K_7" type="tns:TKwotowy">
  <xsd:annotation>
    <xsd:documentation>Przychód - wartość sprzedanych towarów i
usług</xsd:documentation>
  </xsd:annotation>
</xsd:element>
<xsd:element name="K_8" type="tns:TKwotowy">
  <xsd:annotation>
    <xsd:documentation>Przychód - pozostałe przychody</xsd:documentation>
  </xsd:annotation>
</xsd:element>
<xsd:element name="K_9" type="tns:TKwotowy">
  <xsd:annotation>
    <xsd:documentation>Przychód - razem przychód (7+8)</xsd:documentation>
  </xsd:annotation>
</xsd:element>
<xsd:element name="K_10" type="tns:TKwotowy">
  <xsd:annotation>
    <xsd:documentation>Zakup towarów handlowych i materiałów wg cen
zakupu</xsd:documentation>
  </xsd:annotation>
</xsd:element>
<xsd:element name="K_11" type="tns:TKwotowy">
  <xsd:annotation>
    <xsd:documentation>Koszty uboczne zakupu</xsd:documentation>
  </xsd:annotation>
</xsd:element>
<xsd:element name="K_12" type="tns:TKwotowy">
  <xsd:annotation>
    <xsd:documentation>Wydatki (koszty) - wynagrodzenia w gotówce i w
naturze</xsd:documentation>
  </xsd:annotation>
</xsd:element>
<xsd:element name="K_13" type="tns:TKwotowy">
  <xsd:annotation>
    <xsd:documentation>Wydatki (koszty) - pozostałe wydatki</xsd:documentation>
  </xsd:annotation>
</xsd:element>
<xsd:element name="K_14" type="tns:TKwotowy">
  <xsd:annotation>

```

```

        <xsd:documentation>Wydatki (koszty) - razem wydatki
(12+13)</xsd:documentation>
    </xsd:annotation>
</xsd:element>
    <xsd:element name="K_15" type="tns:TKwotowy">
        <xsd:annotation>
            <xsd:documentation>Wydatki (koszty) - pole wolne</xsd:documentation>
        </xsd:annotation>
    </xsd:element>
    <xsd:sequence minOccurs="0">
        <xsd:element name="K_16A" type="tns:TZnakowyJPK">
            <xsd:annotation>
                <xsd:documentation>Koszty działalności badawczo
-rozwojowej, o których mowa w art. 26e ustawy o podatku dochodowym - opis
kosztu</xsd:documentation>
            </xsd:annotation>
        </xsd:element>
        <xsd:element name="K_16B" type="tns:TKwotowy">
            <xsd:annotation>
                <xsd:documentation>Koszty działalności badawczo-rozwojowej, o których mowa
w art. 26e ustawy o podatku dochodowym - wartość</xsd:documentation>
            </xsd:annotation>
        </xsd:element>
    </xsd:sequence>
    <xsd:element name="K_17" type="tns:TZnakowyJPK" minOccurs="0">
        <xsd:annotation>
            <xsd:documentation>Uwagi</xsd:documentation>
        </xsd:annotation>
    </xsd:element>
</xsd:sequence>
    <xsd:attribute name="typ" use="required" fixed="G"/>
</xsd:complexType>
</xsd:element>
<xsd:element name="PKPIRCtrl">
    <xsd:annotation>
        <xsd:documentation>Sumy kontrolne dla tabeli PKPIRWiersz</xsd:documentation>
    </xsd:annotation>
    <xsd:complexType>
        <xsd:sequence>
            <xsd:element name="LiczbaWierszy" type="tns:TNaturalnyJPK">
                <xsd:annotation>
                    <xsd:documentation>Liczba wierszy (zapisów) PKPIR, w okresie którego dotyczy
JPK_PKPIR</xsd:documentation>
                </xsd:annotation>
            </xsd:element>
            <xsd:element name="SumaPrzychodow" type="tns:TKwotowy">
                <xsd:annotation>
                    <xsd:documentation>Łączna wartość przychodów razem (kol. 9) w PKPIR w
okresie, którego dotyczy JPK_PKPIR</xsd:documentation>
                </xsd:annotation>
            </xsd:element>
        </xsd:sequence>
    </xsd:complexType>
</xsd:element>
</xsd:sequence>
</xsd:complexType>

```

</xsd:element>

element JPK/Naglowek

diagram

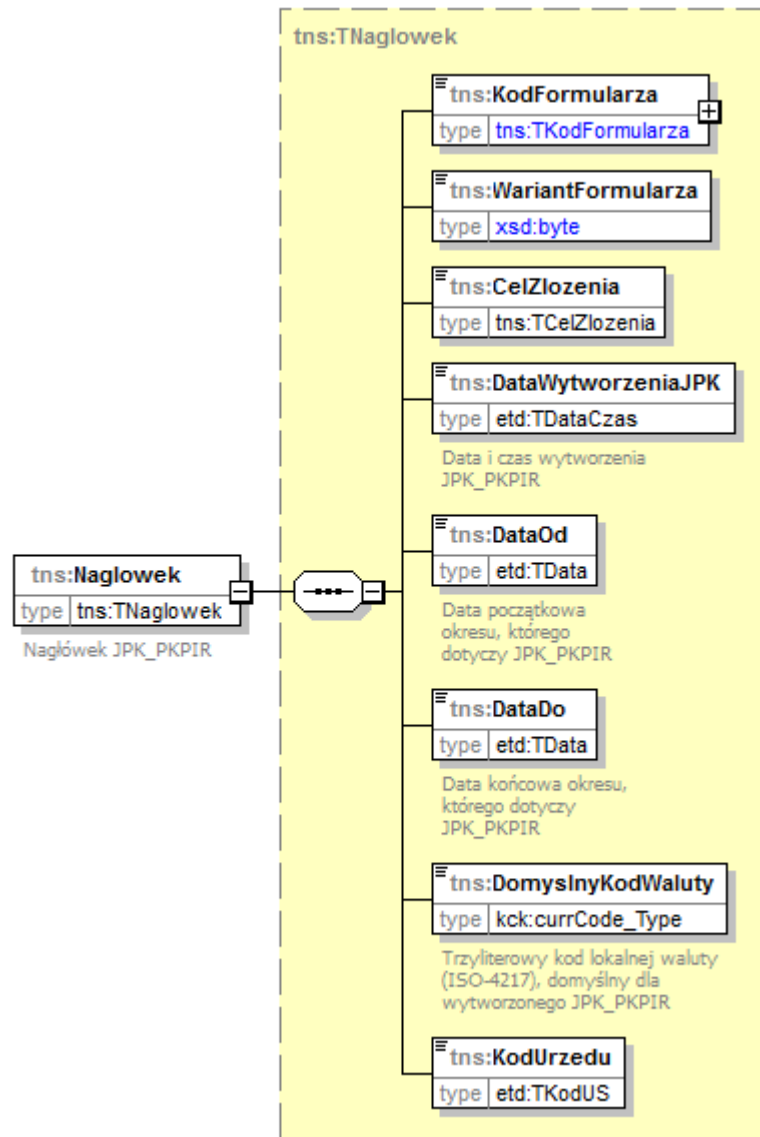

namespace <http://jpk.mf.gov.pl/wzor/2016/10/26/10262/>

type [tns:TNaglowek](#)

properties content complex

children [tns:KodFormularza](#) [tns:WariantFormularza](#) [tns:CelZlozenia](#) [tns:DataWytworzeniaJPK](#) [tns:DataOd](#) [tns:DataDo](#) [tns:DomyslnyKodWaluty](#) [tns:KodUrzedu](#)

annotation documentation
Nagłówek JPK_PKPIR

source

```
<xsd:element name="Naglowek" type="tns:TNaglowek">
  <xsd:annotation>
    <xsd:documentation>Nagłówek JPK_PKPIR</xsd:documentation>
  </xsd:annotation>
```

</xsd:element>

element JPK/Podmiot1

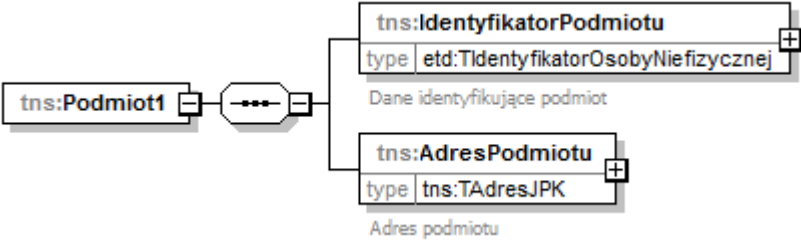
diagram	
namespace	http://jpk.mf.gov.pl/wzor/2016/10/26/10262/
properties	content complex
children	tns:IdentyfikatorPodmiotu tns:AdresPodmiotu
source	<pre><xsd:element name="Podmiot1"> <xsd:complexType> <xsd:sequence> <xsd:element name="IdentyfikatorPodmiotu" type="etd:TIdentyfikatorOsobyNiefizycznej"> <xsd:annotation> <xsd:documentation>Dane identyfikujące podmiot</xsd:documentation> </xsd:annotation> </xsd:element> <xsd:element name="AdresPodmiotu" type="tns:TAdresJPK"> <xsd:annotation> <xsd:documentation>Adres podmiotu</xsd:documentation> </xsd:annotation> </xsd:element> </xsd:sequence> </xsd:complexType> </xsd:element></pre>

element JPK/Podmiot1/IdentyfikatorPodmiotu

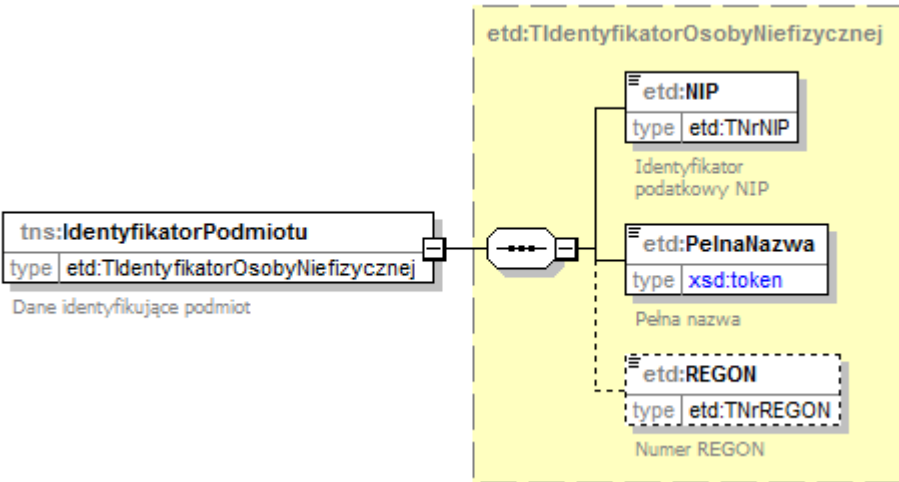
diagram	
---------	--

namespace	http://jpk.mf.gov.pl/wzor/2016/10/26/10262/
type	etd:TIdentyfikatorOsobyNiefizycznej
properties	content complex
children	etd:NIP etd:PeInaNazwa etd:REGON
annotation	documentation Dane identyfikujące podmiot
source	<pre> <xsd:element name="IdentyfikatorPodmiotu" type="etd:TIdentyfikatorOsobyNiefizycznej"> <xsd:annotation> <xsd:documentation>Dane identyfikujące podmiot</xsd:documentation> </xsd:annotation> </xsd:element> </pre>

element **JPK/Podmiot1/AdresPodmiotu**

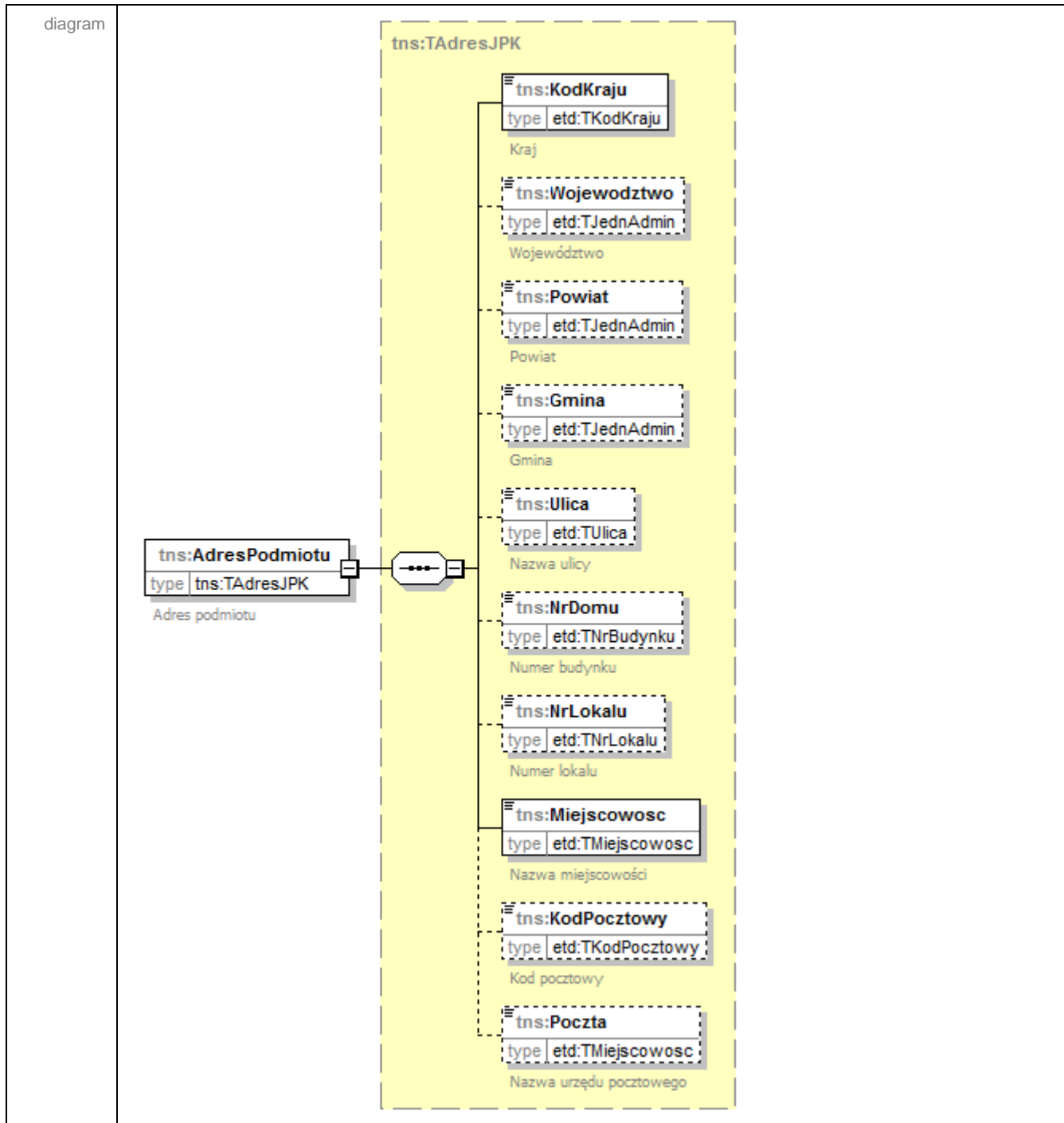

namespace	http://jpk.mf.gov.pl/wzor/2016/10/26/10262/
type	tns:TAdresJPK
properties	content complex
children	tns:KodKraju tns:Wojewodztwo tns:Powiat tns:Gmina tns:Ulica tns:NrDomu tns:NrLokalu tns:Miejscowosc tns:KodPocztowy tns:Poczta
annotation	documentation Adres podmiotu

source	<pre><xsd:element name="AdresPodmiotu" type="tns:TAdresJPK"> <xsd:annotation> <xsd:documentation>Adres podmiotu</xsd:documentation> </xsd:annotation> </xsd:element></pre>
--------	--

element JPK/PKPIRInfo

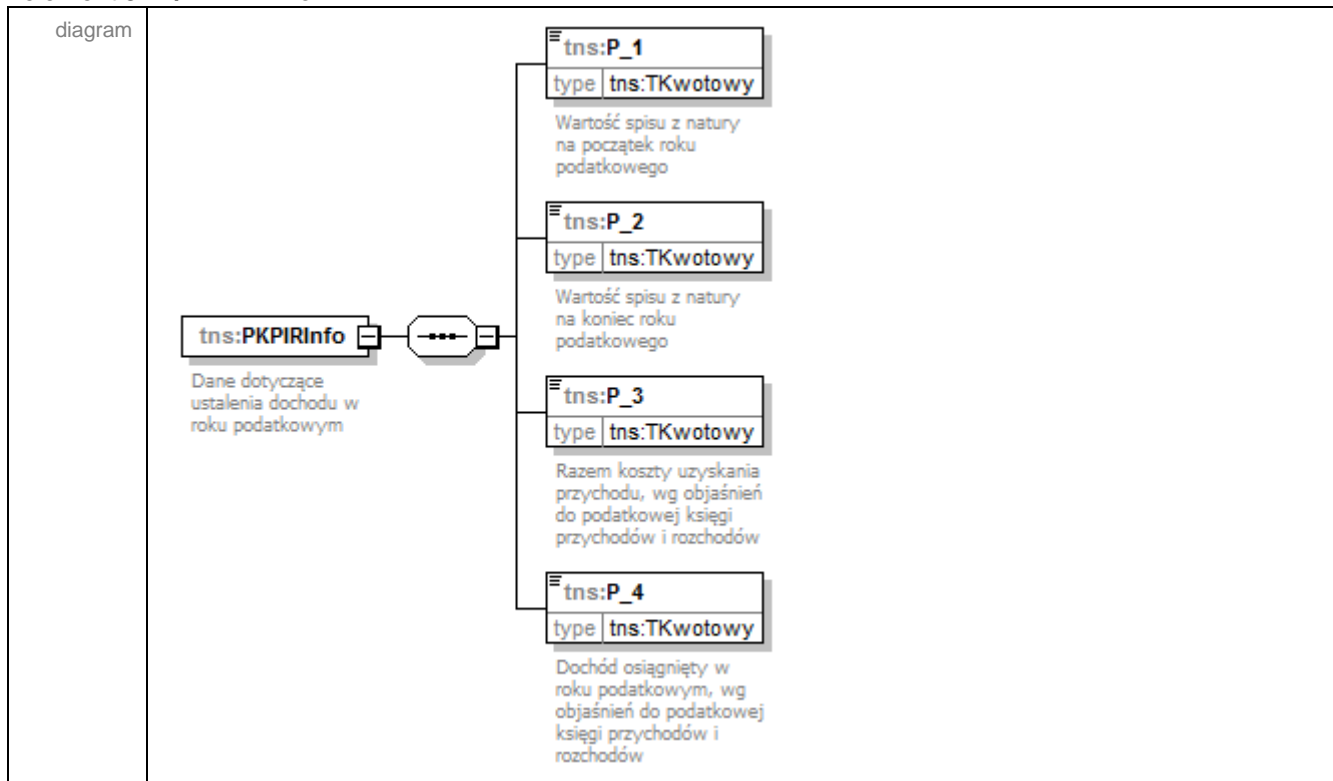

namespace	http://jpk.mf.gov.pl/wzor/2016/10/26/10262/
-----------	---

properties	content complex
------------	-----------------

children	tns:P_1 tns:P_2 tns:P_3 tns:P_4
----------	---

annotation	documentation Dane dotyczące ustalenia dochodu w roku podatkowym
------------	---

source	<pre><xsd:element name="PKPIRInfo"> <xsd:annotation> <xsd:documentation>Dane dotyczące ustalenia dochodu w roku podatkowym</xsd:documentation> </xsd:annotation> <xsd:complexType> <xsd:sequence> <xsd:element name="P_1" type="tns:TKwotowy"> <xsd:annotation> <xsd:documentation>Wartość spisu z natury na początek roku podatkowego</xsd:documentation> </xsd:annotation> </xsd:element> <xsd:element name="P_2" type="tns:TKwotowy"> <xsd:annotation></pre>
--------	---

	<pre> <xsd:documentation>Wartość spisu z natury na koniec roku podatkowego</xsd:documentation> </xsd:annotation> </xsd:element> <xsd:element name="P_3" type="tns:TKwotowy"> <xsd:annotation> <xsd:documentation>Razem koszty uzyskania przychodu, wg objaśnień do podatkowej księgi przychodów i rozchodów</xsd:documentation> </xsd:annotation> </xsd:element> <xsd:element name="P_4" type="tns:TKwotowy"> <xsd:annotation> <xsd:documentation>Dochód osiągnięty w roku podatkowym, wg objaśnień do podatkowej księgi przychodów i rozchodów</xsd:documentation> </xsd:annotation> </xsd:element> </xsd:sequence> </xsd:complexType> </xsd:element> </pre>
--	---

element JPK/PKPIRInfo/P_1

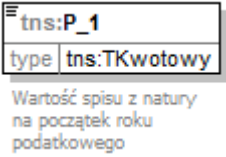
diagram										
namespace	http://jpk.mf.gov.pl/wzor/2016/10/26/10262/									
type	tns:TKwotowy									
properties	content simple									
facets	<table border="1"> <thead> <tr> <th>Kind</th> <th>Value</th> <th>Annotation</th> </tr> </thead> <tbody> <tr> <td>totalDigits</td> <td>18</td> <td></td> </tr> <tr> <td>fractionDigits</td> <td>2</td> <td></td> </tr> </tbody> </table>	Kind	Value	Annotation	totalDigits	18		fractionDigits	2	
Kind	Value	Annotation								
totalDigits	18									
fractionDigits	2									
annotation	documentation Wartość spisu z natury na początek roku podatkowego									
source	<pre> <xsd:element name="P_1" type="tns:TKwotowy"> <xsd:annotation> <xsd:documentation>Wartość spisu z natury na początek roku podatkowego</xsd:documentation> </xsd:annotation> </xsd:element> </pre>									

element JPK/PKPIRInfo/P_2

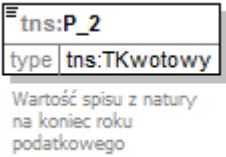
diagram	
namespace	http://jpk.mf.gov.pl/wzor/2016/10/26/10262/

type	tns:TKwotowy									
properties	content simple									
facets	<table border="1"> <thead> <tr> <th>Kind</th> <th>Value</th> <th>Annotation</th> </tr> </thead> <tbody> <tr> <td>totalDigits</td> <td>18</td> <td></td> </tr> <tr> <td>fractionDigits</td> <td>2</td> <td></td> </tr> </tbody> </table>	Kind	Value	Annotation	totalDigits	18		fractionDigits	2	
Kind	Value	Annotation								
totalDigits	18									
fractionDigits	2									
annotation	documentation Wartość spisu z natury na koniec roku podatkowego									
source	<pre><xsd:element name="P_2" type="tns:TKwotowy"> <xsd:annotation> <xsd:documentation>Wartość spisu z natury na koniec roku podatkowego</xsd:documentation> </xsd:annotation> </xsd:element></pre>									

element JPK/PKPIRInfo/P_3

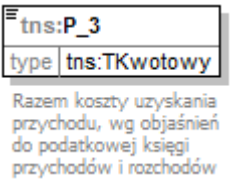
diagram										
namespace	http://jpk.mf.gov.pl/wzor/2016/10/26/10262/									
type	tns:TKwotowy									
properties	content simple									
facets	<table border="1"> <thead> <tr> <th>Kind</th> <th>Value</th> <th>Annotation</th> </tr> </thead> <tbody> <tr> <td>totalDigits</td> <td>18</td> <td></td> </tr> <tr> <td>fractionDigits</td> <td>2</td> <td></td> </tr> </tbody> </table>	Kind	Value	Annotation	totalDigits	18		fractionDigits	2	
Kind	Value	Annotation								
totalDigits	18									
fractionDigits	2									
annotation	documentation Razem koszty uzyskania przychodu, wg objaśnień do podatkowej księgi przychodów i rozchodów									
source	<pre><xsd:element name="P_3" type="tns:TKwotowy"> <xsd:annotation> <xsd:documentation>Razem koszty uzyskania przychodu, wg objaśnień do podatkowej księgi przychodów i rozchodów</xsd:documentation> </xsd:annotation> </xsd:element></pre>									

element JPK/PKPIRInfo/P_4

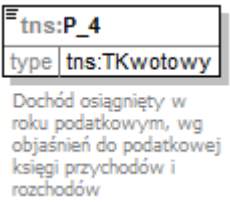
diagram	
namespace	http://jpk.mf.gov.pl/wzor/2016/10/26/10262/
type	tns:TKwotowy

properties	content simple									
facets	<table border="1"> <tr> <td>Kind</td> <td>Value</td> <td>Annotation</td> </tr> <tr> <td>totalDigits</td> <td>18</td> <td></td> </tr> <tr> <td>fractionDigits</td> <td>2</td> <td></td> </tr> </table>	Kind	Value	Annotation	totalDigits	18		fractionDigits	2	
Kind	Value	Annotation								
totalDigits	18									
fractionDigits	2									
annotation	documentation Dochód osiągnięty w roku podatkowym, wg objaśnień do podatkowej księgi przychodów i rozchodów									
source	<pre><xsd:element name="P_4" type="tns:TKwotowy"> <xsd:annotation> <xsd:documentation>Dochód osiągnięty w roku podatkowym, wg objaśnień do podatkowej księgi przychodów i rozchodów</xsd:documentation> </xsd:annotation> </xsd:element></pre>									

element JPK/PKPIRSpis

diagram													
namespace	http://jpk.mf.gov.pl/wzor/2016/10/26/10262/												
properties	<table border="1"> <tr> <td>minOcc</td> <td>0</td> </tr> <tr> <td>maxOcc</td> <td>unbounded</td> </tr> <tr> <td>content</td> <td>complex</td> </tr> </table>	minOcc	0	maxOcc	unbounded	content	complex						
minOcc	0												
maxOcc	unbounded												
content	complex												
children	tns:P_5A tns:P_5B												
attributes	<table border="1"> <thead> <tr> <th>Name</th> <th>Type</th> <th>Use</th> <th>Default</th> <th>Fixed</th> <th>Annotation</th> </tr> </thead> <tbody> <tr> <td>typ</td> <td></td> <td>required</td> <td></td> <td>G</td> <td></td> </tr> </tbody> </table>	Name	Type	Use	Default	Fixed	Annotation	typ		required		G	
Name	Type	Use	Default	Fixed	Annotation								
typ		required		G									
annotation	documentation Spisy z natury sporządzone w ciągu roku podatkowego												
source	<pre><xsd:element name="PKPIRSpis" minOccurs="0" maxOccurs="unbounded"> <xsd:annotation> <xsd:documentation>Spisy z natury sporządzone w ciągu roku podatkowego</xsd:documentation> </xsd:annotation> <xsd:complexType> <xsd:sequence minOccurs="0"> <xsd:element name="P_5A" type="etd:TData"> <xsd:annotation> <xsd:documentation>Data spisu z natury sporządzonego w ciągu roku podatkowego</xsd:documentation> </xsd:annotation> </xsd:element> </xsd:sequence> </xsd:complexType> </xsd:element></pre>												

	<pre> <xsd:element name="P_5B" type="tns:TKwotowy"> <xsd:annotation> <xsd:documentation>Wartość spisu z natury sporządzonego w ciągu roku podatkowego</xsd:documentation> </xsd:annotation> </xsd:element> </xsd:sequence> <xsd:attribute name="typ" use="required" fixed="G"/> </xsd:complexType> </xsd:element> </pre>
--	--

attribute JPK/PKPIRSpis/@typ

properties	<table border="0"> <tr> <td>use</td> <td>required</td> </tr> <tr> <td>fixed</td> <td>G</td> </tr> </table>	use	required	fixed	G
use	required				
fixed	G				
source	<code><xsd:attribute name="typ" use="required" fixed="G"/></code>				

element JPK/PKPIRSpis/P_5A

diagram													
namespace	http://jpk.mf.gov.pl/wzor/2016/10/26/10262/												
type	etd:TData												
properties	content simple												
facets	<table border="0"> <thead> <tr> <th>Kind</th> <th>Value</th> <th>Annotation</th> </tr> </thead> <tbody> <tr> <td>minInclusive</td> <td>1900-01-01</td> <td></td> </tr> <tr> <td>maxInclusive</td> <td>2030-12-31</td> <td></td> </tr> <tr> <td>pattern</td> <td>((\d{4})-(\d{2})-(\d{2}))</td> <td></td> </tr> </tbody> </table>	Kind	Value	Annotation	minInclusive	1900-01-01		maxInclusive	2030-12-31		pattern	((\d{4})-(\d{2})-(\d{2}))	
Kind	Value	Annotation											
minInclusive	1900-01-01												
maxInclusive	2030-12-31												
pattern	((\d{4})-(\d{2})-(\d{2}))												
annotation	documentation Data spisu z natury sporządzonego w ciągu roku podatkowego												
source	<pre> <xsd:element name="P_5A" type="etd:TData"> <xsd:annotation> <xsd:documentation>Data spisu z natury sporządzonego w ciągu roku podatkowego</xsd:documentation> </xsd:annotation> </xsd:element> </pre>												

element JPK/PKPIRSpis/P_5B

diagram	
namespace	http://jpk.mf.gov.pl/wzor/2016/10/26/10262/

type	tns:TKwotowy									
properties	content simple									
facets	<table> <thead> <tr> <th>Kind</th> <th>Value</th> <th>Annotation</th> </tr> </thead> <tbody> <tr> <td>totalDigits</td> <td>18</td> <td></td> </tr> <tr> <td>fractionDigits</td> <td>2</td> <td></td> </tr> </tbody> </table>	Kind	Value	Annotation	totalDigits	18		fractionDigits	2	
Kind	Value	Annotation								
totalDigits	18									
fractionDigits	2									
annotation	documentation Wartość spisu z natury sporządzonego w ciągu roku podatkowego									
source	<pre> <xsd:element name="P_5B" type="tns:TKwotowy"> <xsd:annotation> <xsd:documentation>Wartość spisu z natury sporządzonego w ciągu roku podatkowego</xsd:documentation> </xsd:annotation> </xsd:element> </pre>									

element JPK/PKPIRWiersz

diagram

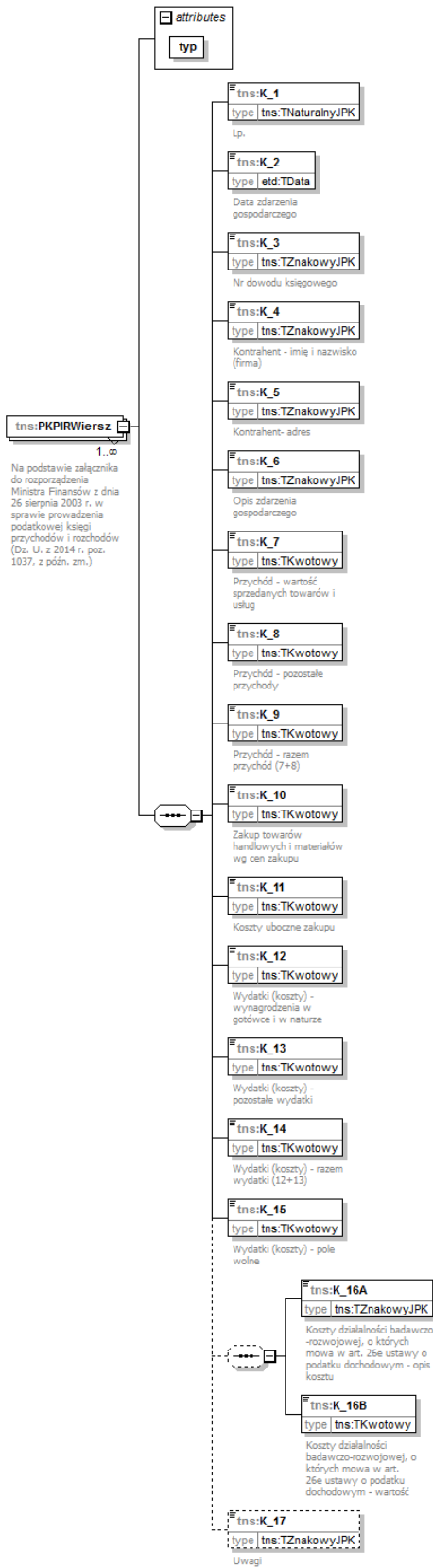

namespace	http://jpk.mf.gov.pl/wzor/2016/10/26/10262/					
properties	minOcc	1	maxOcc	unbounded	content	complex
children	tns:K_1 tns:K_2 tns:K_3 tns:K_4 tns:K_5 tns:K_6 tns:K_7 tns:K_8 tns:K_9 tns:K_10 tns:K_11 tns:K_12 tns:K_13 tns:K_14 tns:K_15 tns:K_16A tns:K_16B tns:K_17					
attributes	Name	Type	Use	Default	Fixed	Annotation
	typ		required		G	
annotation	documentation Na podstawie załącznika do rozporządzenia Ministra Finansów z dnia 26 sierpnia 2003 r. w sprawie prowadzenia podatkowej księgi przychodów i rozchodów (Dz. U. z 2014 r. poz. 1037, z późn. zm.)					
source	<pre> <xsd:element name="PKPIRWiersz" maxOccurs="unbounded"> <xsd:annotation> <xsd:documentation>Na podstawie załącznika do rozporządzenia Ministra Finansów z dnia 26 sierpnia 2003 r. w sprawie prowadzenia podatkowej księgi przychodów i rozchodów (Dz. U. z 2014 r. poz. 1037, z późn. zm.)</xsd:documentation> </xsd:annotation> <xsd:complexType> <xsd:sequence> <xsd:element name="K_1" type="tns:TNaturalnyJPK"> <xsd:annotation> <xsd:documentation>Lp.</xsd:documentation> </xsd:annotation> </xsd:element> <xsd:element name="K_2" type="etd:TData"> <xsd:annotation> <xsd:documentation>Data zdarzenia gospodarczego</xsd:documentation> </xsd:annotation> </xsd:element> <xsd:element name="K_3" type="tns:TZnakowyJPK"> <xsd:annotation> <xsd:documentation>Nr dowodu księgowego</xsd:documentation> </xsd:annotation> </xsd:element> <xsd:element name="K_4" type="tns:TZnakowyJPK"> <xsd:annotation> <xsd:documentation>Kontrahent - imię i nazwisko (firma)</xsd:documentation> </xsd:annotation> </xsd:element> <xsd:element name="K_5" type="tns:TZnakowyJPK"> <xsd:annotation> <xsd:documentation>Kontrahent- adres</xsd:documentation> </xsd:annotation> </xsd:element> <xsd:element name="K_6" type="tns:TZnakowyJPK"> <xsd:annotation> <xsd:documentation>Opis zdarzenia gospodarczego</xsd:documentation> </xsd:annotation> </xsd:element> <xsd:element name="K_7" type="tns:TKwotowy"> <xsd:annotation> <xsd:documentation>Przychód - wartość sprzedanych towarów i usług</xsd:documentation> </xsd:annotation> </xsd:element> <xsd:element name="K_8" type="tns:TKwotowy"> </pre>					

```

    <xsd:annotation>
      <xsd:documentation>Przychód - pozostałe przychody</xsd:documentation>
    </xsd:annotation>
  </xsd:element>
  <xsd:element name="K_9" type="tns:TKwotowy">
    <xsd:annotation>
      <xsd:documentation>Przychód - razem przychód (7+8)</xsd:documentation>
    </xsd:annotation>
  </xsd:element>
  <xsd:element name="K_10" type="tns:TKwotowy">
    <xsd:annotation>
      <xsd:documentation>Zakup towarów handlowych i materiałów wg cen
zakupu</xsd:documentation>
    </xsd:annotation>
  </xsd:element>
  <xsd:element name="K_11" type="tns:TKwotowy">
    <xsd:annotation>
      <xsd:documentation>Koszty uboczne zakupu</xsd:documentation>
    </xsd:annotation>
  </xsd:element>
  <xsd:element name="K_12" type="tns:TKwotowy">
    <xsd:annotation>
      <xsd:documentation>Wydatki (koszty) - wynagrodzenia w gotówce i w
naturze</xsd:documentation>
    </xsd:annotation>
  </xsd:element>
  <xsd:element name="K_13" type="tns:TKwotowy">
    <xsd:annotation>
      <xsd:documentation>Wydatki (koszty) - pozostałe wydatki</xsd:documentation>
    </xsd:annotation>
  </xsd:element>
  <xsd:element name="K_14" type="tns:TKwotowy">
    <xsd:annotation>
      <xsd:documentation>Wydatki (koszty) - razem wydatki (12+13)</xsd:documentation>
    </xsd:annotation>
  </xsd:element>
  <xsd:element name="K_15" type="tns:TKwotowy">
    <xsd:annotation>
      <xsd:documentation>Wydatki (koszty) - pole wolne</xsd:documentation>
    </xsd:annotation>
  </xsd:element>
  <xsd:sequence minOccurs="0">
    <xsd:element name="K_16A" type="tns:TZnakowyJPK">
      <xsd:annotation>
        <xsd:documentation>Koszty działalności badawczo
-rozwojowej, o których mowa w art. 26e ustawy o podatku dochodowym - opis
kosztu</xsd:documentation>
      </xsd:annotation>
    </xsd:element>
    <xsd:element name="K_16B" type="tns:TKwotowy">
      <xsd:annotation>
        <xsd:documentation>Koszty działalności badawczo-rozwojowej, o których mowa w art.
26e ustawy o podatku dochodowym - wartość</xsd:documentation>
      </xsd:annotation>
    </xsd:element>
  </xsd:sequence>

```

	<pre> <xsd:element name="K_17" type="tns:TZnakowyJPK" minOccurs="0"> <xsd:annotation> <xsd:documentation>Uwagi</xsd:documentation> </xsd:annotation> </xsd:element> </xsd:sequence> <xsd:attribute name="typ" use="required" fixed="G"/> </xsd:complexType> </xsd:element> </pre>
--	---

attribute JPK/PKPIRWiersz/@typ

properties	<table border="0"> <tr> <td>use</td> <td>required</td> </tr> <tr> <td>fixed</td> <td>G</td> </tr> </table>	use	required	fixed	G
use	required				
fixed	G				
source	<code><xsd:attribute name="typ" use="required" fixed="G"/></code>				

element JPK/PKPIRWiersz/K_1

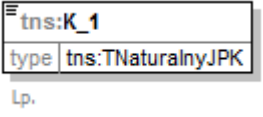
diagram													
namespace	http://jpk.mf.gov.pl/wzor/2016/10/26/10262/												
type	tns:TNaturalnyJPK												
properties	content simple												
facets	<table border="0"> <thead> <tr> <th>Kind</th> <th>Value</th> <th>Annotation</th> </tr> </thead> <tbody> <tr> <td>minExclusive</td> <td>0</td> <td></td> </tr> <tr> <td>totalDigits</td> <td>14</td> <td></td> </tr> <tr> <td>whiteSpace</td> <td>collapse</td> <td></td> </tr> </tbody> </table>	Kind	Value	Annotation	minExclusive	0		totalDigits	14		whiteSpace	collapse	
Kind	Value	Annotation											
minExclusive	0												
totalDigits	14												
whiteSpace	collapse												
annotation	documentation Lp.												
source	<pre> <xsd:element name="K_1" type="tns:TNaturalnyJPK"> <xsd:annotation> <xsd:documentation>Lp.</xsd:documentation> </xsd:annotation> </xsd:element> </pre>												

element JPK/PKPIRWiersz/K_2

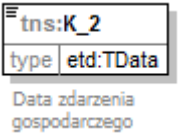
diagram							
namespace	http://jpk.mf.gov.pl/wzor/2016/10/26/10262/						
type	etd:TData						
properties	content simple						
facets	<table border="0"> <thead> <tr> <th>Kind</th> <th>Value</th> <th>Annotation</th> </tr> </thead> <tbody> <tr> <td>minInclusive</td> <td>1900-01-01</td> <td></td> </tr> </tbody> </table>	Kind	Value	Annotation	minInclusive	1900-01-01	
Kind	Value	Annotation					
minInclusive	1900-01-01						

	maxInclusive 2030-12-31 pattern ((\d{4})-(\d{2})-(\d{2}))
annotation	documentation Data zdarzenia gospodarczego
source	<xsd:element name="K_2" type="etd:TData"> <xsd:annotation> <xsd:documentation>Data zdarzenia gospodarczego</xsd:documentation> </xsd:annotation> </xsd:element>

element JPK/PKPIRWiersz/K_3

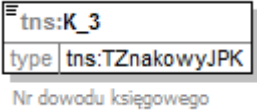
diagram										
namespace	http://jpk.mf.gov.pl/wzor/2016/10/26/10262/									
type	tns:TZnakowyJPK									
properties	content simple									
facets	<table border="1"> <thead> <tr> <th>Kind</th> <th>Value</th> <th>Annotation</th> </tr> </thead> <tbody> <tr> <td>minLength</td> <td>1</td> <td></td> </tr> <tr> <td>maxLength</td> <td>256</td> <td></td> </tr> </tbody> </table>	Kind	Value	Annotation	minLength	1		maxLength	256	
Kind	Value	Annotation								
minLength	1									
maxLength	256									
annotation	documentation Nr dowodu księgowego									
source	<xsd:element name="K_3" type="tns:TZnakowyJPK"> <xsd:annotation> <xsd:documentation>Nr dowodu księgowego</xsd:documentation> </xsd:annotation> </xsd:element>									

element JPK/PKPIRWiersz/K_4

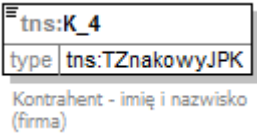
diagram										
namespace	http://jpk.mf.gov.pl/wzor/2016/10/26/10262/									
type	tns:TZnakowyJPK									
properties	content simple									
facets	<table border="1"> <thead> <tr> <th>Kind</th> <th>Value</th> <th>Annotation</th> </tr> </thead> <tbody> <tr> <td>minLength</td> <td>1</td> <td></td> </tr> <tr> <td>maxLength</td> <td>256</td> <td></td> </tr> </tbody> </table>	Kind	Value	Annotation	minLength	1		maxLength	256	
Kind	Value	Annotation								
minLength	1									
maxLength	256									
annotation	documentation Kontrahent - imię i nazwisko (firma)									
source	<xsd:element name="K_4" type="tns:TZnakowyJPK"> <xsd:annotation> <xsd:documentation>Kontrahent - imię i nazwisko (firma)</xsd:documentation> </xsd:annotation> </xsd:element>									

	<code></xsd:element></code>
--	-----------------------------------

element JPK/PKPIRWiersz/K_5

diagram	<pre> graph TD K5["tns:K_5 type tns:TZnakowyJPK Kontrahent- adres"] </pre>									
namespace	http://jpk.mf.gov.pl/wzor/2016/10/26/10262/									
type	tns:TZnakowyJPK									
properties	content simple									
facets	<table border="1"> <thead> <tr> <th>Kind</th> <th>Value</th> <th>Annotation</th> </tr> </thead> <tbody> <tr> <td>minLength</td> <td>1</td> <td></td> </tr> <tr> <td>maxLength</td> <td>256</td> <td></td> </tr> </tbody> </table>	Kind	Value	Annotation	minLength	1		maxLength	256	
Kind	Value	Annotation								
minLength	1									
maxLength	256									
annotation	documentation Kontrahent- adres									
source	<pre> <xsd:element name="K_5" type="tns:TZnakowyJPK"> <xsd:annotation> <xsd:documentation>Kontrahent- adres</xsd:documentation> </xsd:annotation> </xsd:element> </pre>									

element JPK/PKPIRWiersz/K_6

diagram	<pre> graph TD K6["tns:K_6 type tns:TZnakowyJPK Opis zdarzenia gospodarczego"] </pre>									
namespace	http://jpk.mf.gov.pl/wzor/2016/10/26/10262/									
type	tns:TZnakowyJPK									
properties	content simple									
facets	<table border="1"> <thead> <tr> <th>Kind</th> <th>Value</th> <th>Annotation</th> </tr> </thead> <tbody> <tr> <td>minLength</td> <td>1</td> <td></td> </tr> <tr> <td>maxLength</td> <td>256</td> <td></td> </tr> </tbody> </table>	Kind	Value	Annotation	minLength	1		maxLength	256	
Kind	Value	Annotation								
minLength	1									
maxLength	256									
annotation	documentation Opis zdarzenia gospodarczego									
source	<pre> <xsd:element name="K_6" type="tns:TZnakowyJPK"> <xsd:annotation> <xsd:documentation>Opis zdarzenia gospodarczego</xsd:documentation> </xsd:annotation> </xsd:element> </pre>									

element JPK/PKPIRWiersz/K_7

diagram	 <p>Przychód - wartość sprzedanych towarów i usług</p>									
namespace	http://jpk.mf.gov.pl/wzor/2016/10/26/10262/									
type	tns:TKwotowy									
properties	content simple									
facets	<table border="1"> <thead> <tr> <th>Kind</th> <th>Value</th> <th>Annotation</th> </tr> </thead> <tbody> <tr> <td>totalDigits</td> <td>18</td> <td></td> </tr> <tr> <td>fractionDigits</td> <td>2</td> <td></td> </tr> </tbody> </table>	Kind	Value	Annotation	totalDigits	18		fractionDigits	2	
Kind	Value	Annotation								
totalDigits	18									
fractionDigits	2									
annotation	documentation Przychód - wartość sprzedanych towarów i usług									
source	<pre><xsd:element name="K_7" type="tns:TKwotowy"> <xsd:annotation> <xsd:documentation>Przychód - wartość sprzedanych towarów i usług</xsd:documentation> </xsd:annotation> </xsd:element></pre>									

element JPK/PKPIRWiersz/K_8

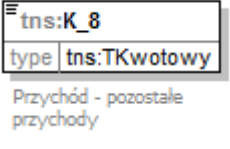
diagram	 <p>Przychód - pozostałe przychody</p>									
namespace	http://jpk.mf.gov.pl/wzor/2016/10/26/10262/									
type	tns:TKwotowy									
properties	content simple									
facets	<table border="1"> <thead> <tr> <th>Kind</th> <th>Value</th> <th>Annotation</th> </tr> </thead> <tbody> <tr> <td>totalDigits</td> <td>18</td> <td></td> </tr> <tr> <td>fractionDigits</td> <td>2</td> <td></td> </tr> </tbody> </table>	Kind	Value	Annotation	totalDigits	18		fractionDigits	2	
Kind	Value	Annotation								
totalDigits	18									
fractionDigits	2									
annotation	documentation Przychód - pozostałe przychody									
source	<pre><xsd:element name="K_8" type="tns:TKwotowy"> <xsd:annotation> <xsd:documentation>Przychód - pozostałe przychody</xsd:documentation> </xsd:annotation> </xsd:element></pre>									

element JPK/PKPIRWiersz/K_9

diagram	 <p>Przychód - razem przychód (7+8)</p>
---------	--

namespace	http://jpk.mf.gov.pl/wzor/2016/10/26/10262/									
type	tns:TKwotowy									
properties	content simple									
facets	<table border="1"> <thead> <tr> <th>Kind</th> <th>Value</th> <th>Annotation</th> </tr> </thead> <tbody> <tr> <td>totalDigits</td> <td>18</td> <td></td> </tr> <tr> <td>fractionDigits</td> <td>2</td> <td></td> </tr> </tbody> </table>	Kind	Value	Annotation	totalDigits	18		fractionDigits	2	
Kind	Value	Annotation								
totalDigits	18									
fractionDigits	2									
annotation	documentation Przychód - razem przychód (7+8)									
source	<pre><xsd:element name="K_9" type="tns:TKwotowy"> <xsd:annotation> <xsd:documentation>Przychód - razem przychód (7+8)</xsd:documentation> </xsd:annotation> </xsd:element></pre>									

element JPK/PKPIRWiersz/K_10

diagram										
namespace	http://jpk.mf.gov.pl/wzor/2016/10/26/10262/									
type	tns:TKwotowy									
properties	content simple									
facets	<table border="1"> <thead> <tr> <th>Kind</th> <th>Value</th> <th>Annotation</th> </tr> </thead> <tbody> <tr> <td>totalDigits</td> <td>18</td> <td></td> </tr> <tr> <td>fractionDigits</td> <td>2</td> <td></td> </tr> </tbody> </table>	Kind	Value	Annotation	totalDigits	18		fractionDigits	2	
Kind	Value	Annotation								
totalDigits	18									
fractionDigits	2									
annotation	documentation Zakup towarów handlowych i materiałów wg cen zakupu									
source	<pre><xsd:element name="K_10" type="tns:TKwotowy"> <xsd:annotation> <xsd:documentation>Zakup towarów handlowych i materiałów wg cen zakupu</xsd:documentation> </xsd:annotation> </xsd:element></pre>									

element JPK/PKPIRWiersz/K_11

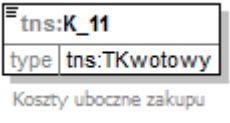
diagram							
namespace	http://jpk.mf.gov.pl/wzor/2016/10/26/10262/						
type	tns:TKwotowy						
properties	content simple						
facets	<table border="1"> <thead> <tr> <th>Kind</th> <th>Value</th> <th>Annotation</th> </tr> </thead> <tbody> <tr> <td>totalDigits</td> <td>18</td> <td></td> </tr> </tbody> </table>	Kind	Value	Annotation	totalDigits	18	
Kind	Value	Annotation					
totalDigits	18						

	fractionDigits 2
annotation	documentation Koszty uboczne zakupu
source	<xsd:element name="K_11" type="tns:TKwotowy"> <xsd:annotation> <xsd:documentation>Koszty uboczne zakupu</xsd:documentation> </xsd:annotation> </xsd:element>

element JPK/PKPIRWiersz/K_12

diagram										
namespace	http://jpk.mf.gov.pl/wzor/2016/10/26/10262/									
type	tns:TKwotowy									
properties	content simple									
facets	<table border="1"> <thead> <tr> <th>Kind</th> <th>Value</th> <th>Annotation</th> </tr> </thead> <tbody> <tr> <td>totalDigits</td> <td>18</td> <td></td> </tr> <tr> <td>fractionDigits</td> <td>2</td> <td></td> </tr> </tbody> </table>	Kind	Value	Annotation	totalDigits	18		fractionDigits	2	
Kind	Value	Annotation								
totalDigits	18									
fractionDigits	2									
annotation	documentation Wydatki (koszty) - wynagrodzenia w gotówce i w naturze									
source	<xsd:element name="K_12" type="tns:TKwotowy"> <xsd:annotation> <xsd:documentation>Wydatki (koszty) - wynagrodzenia w gotówce i w naturze</xsd:documentation> </xsd:annotation> </xsd:element>									

element JPK/PKPIRWiersz/K_13

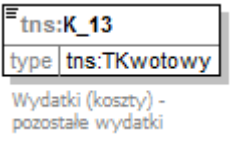
diagram										
namespace	http://jpk.mf.gov.pl/wzor/2016/10/26/10262/									
type	tns:TKwotowy									
properties	content simple									
facets	<table border="1"> <thead> <tr> <th>Kind</th> <th>Value</th> <th>Annotation</th> </tr> </thead> <tbody> <tr> <td>totalDigits</td> <td>18</td> <td></td> </tr> <tr> <td>fractionDigits</td> <td>2</td> <td></td> </tr> </tbody> </table>	Kind	Value	Annotation	totalDigits	18		fractionDigits	2	
Kind	Value	Annotation								
totalDigits	18									
fractionDigits	2									
annotation	documentation Wydatki (koszty) - pozostałe wydatki									
source	<xsd:element name="K_13" type="tns:TKwotowy"> <xsd:annotation> <xsd:documentation>Wydatki (koszty) - pozostałe wydatki</xsd:documentation> </xsd:annotation> </xsd:element>									

	<pre></xsd:annotation> </xsd:element></pre>
--	---

element JPK/PKPIRWiersz/K_14

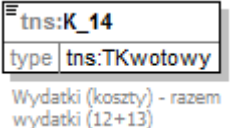
diagram										
namespace	http://jpk.mf.gov.pl/wzor/2016/10/26/10262/									
type	tns:TKwotowy									
properties	content simple									
facets	<table border="1"> <thead> <tr> <th>Kind</th> <th>Value</th> <th>Annotation</th> </tr> </thead> <tbody> <tr> <td>totalDigits</td> <td>18</td> <td></td> </tr> <tr> <td>fractionDigits</td> <td>2</td> <td></td> </tr> </tbody> </table>	Kind	Value	Annotation	totalDigits	18		fractionDigits	2	
Kind	Value	Annotation								
totalDigits	18									
fractionDigits	2									
annotation	documentation Wydatki (koszty) - razem wydatki (12+13)									
source	<pre><xsd:element name="K_14" type="tns:TKwotowy"> <xsd:annotation> <xsd:documentation>Wydatki (koszty) - razem wydatki (12+13)</xsd:documentation> </xsd:annotation> </xsd:element></pre>									

element JPK/PKPIRWiersz/K_15

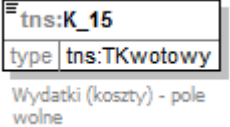
diagram										
namespace	http://jpk.mf.gov.pl/wzor/2016/10/26/10262/									
type	tns:TKwotowy									
properties	content simple									
facets	<table border="1"> <thead> <tr> <th>Kind</th> <th>Value</th> <th>Annotation</th> </tr> </thead> <tbody> <tr> <td>totalDigits</td> <td>18</td> <td></td> </tr> <tr> <td>fractionDigits</td> <td>2</td> <td></td> </tr> </tbody> </table>	Kind	Value	Annotation	totalDigits	18		fractionDigits	2	
Kind	Value	Annotation								
totalDigits	18									
fractionDigits	2									
annotation	documentation Wydatki (koszty) - pole wolne									
source	<pre><xsd:element name="K_15" type="tns:TKwotowy"> <xsd:annotation> <xsd:documentation>Wydatki (koszty) - pole wolne</xsd:documentation> </xsd:annotation> </xsd:element></pre>									

element JPK/PKPIRWiersz/K_16A

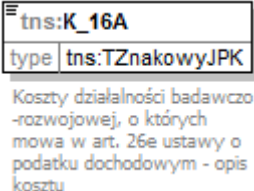
diagram										
namespace	http://jpk.mf.gov.pl/wzor/2016/10/26/10262/									
type	tns:TZnakowyJPK									
properties	content simple									
facets	<table border="1"> <thead> <tr> <th>Kind</th> <th>Value</th> <th>Annotation</th> </tr> </thead> <tbody> <tr> <td>minLength</td> <td>1</td> <td></td> </tr> <tr> <td>maxLength</td> <td>256</td> <td></td> </tr> </tbody> </table>	Kind	Value	Annotation	minLength	1		maxLength	256	
Kind	Value	Annotation								
minLength	1									
maxLength	256									
annotation	documentation Koszty działalności badawczo-rozwojowej, o których mowa w art. 26e ustawy o podatku dochodowym - opis kosztu									
source	<pre><xsd:element name="K_16A" type="tns:TZnakowyJPK"> <xsd:annotation> <xsd:documentation>Koszty działalności badawczo-rozwojowej, o których mowa w art. 26e ustawy o podatku dochodowym - opis kosztu</xsd:documentation> </xsd:annotation> </xsd:element></pre>									

element JPK/PKPIRWiersz/K_16B

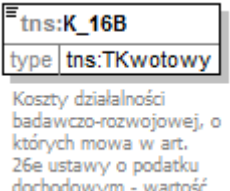
diagram										
namespace	http://jpk.mf.gov.pl/wzor/2016/10/26/10262/									
type	tns:TKwotowy									
properties	content simple									
facets	<table border="1"> <thead> <tr> <th>Kind</th> <th>Value</th> <th>Annotation</th> </tr> </thead> <tbody> <tr> <td>totalDigits</td> <td>18</td> <td></td> </tr> <tr> <td>fractionDigits</td> <td>2</td> <td></td> </tr> </tbody> </table>	Kind	Value	Annotation	totalDigits	18		fractionDigits	2	
Kind	Value	Annotation								
totalDigits	18									
fractionDigits	2									
annotation	documentation Koszty działalności badawczo-rozwojowej, o których mowa w art. 26e ustawy o podatku dochodowym - wartość									
source	<pre><xsd:element name="K_16B" type="tns:TKwotowy"> <xsd:annotation> <xsd:documentation>Koszty działalności badawczo-rozwojowej, o których mowa w art. 26e ustawy o podatku dochodowym - wartość</xsd:documentation> </xsd:annotation> </xsd:element></pre>									

element JPK/PKPIRWiersz/K_17

diagram										
namespace	http://jpk.mf.gov.pl/wzor/2016/10/26/10262/									
type	tns:TZnakowyJPK									
properties	minOcc 0 maxOcc 1 content simple									
facets	<table border="1"> <thead> <tr> <th>Kind</th> <th>Value</th> <th>Annotation</th> </tr> </thead> <tbody> <tr> <td>minLength</td> <td>1</td> <td></td> </tr> <tr> <td>maxLength</td> <td>256</td> <td></td> </tr> </tbody> </table>	Kind	Value	Annotation	minLength	1		maxLength	256	
Kind	Value	Annotation								
minLength	1									
maxLength	256									
annotation	documentation Uwagi									
source	<pre><xsd:element name="K_17" type="tns:TZnakowyJPK" minOccurs="0"> <xsd:annotation> <xsd:documentation>Uwagi</xsd:documentation> </xsd:annotation> </xsd:element></pre>									

element JPK/PKPIRCtrl

diagram	
namespace	http://jpk.mf.gov.pl/wzor/2016/10/26/10262/
properties	content complex
children	tns:LiczbaWierszy tns:SumaPrzychodow
annotation	documentation Sumy kontrolne dla tabeli PKPIRWiersz
source	<pre><xsd:element name="PKPIRCtrl"> <xsd:annotation> <xsd:documentation>Sumy kontrolne dla tabeli PKPIRWiersz</xsd:documentation> </xsd:annotation> <xsd:complexType> <xsd:sequence> <xsd:element name="LiczbaWierszy" type="tns:TNaturalnyJPK"> <xsd:annotation> <xsd:documentation>Liczba wierszy (zapisów) PKPIR, w okresie którego dotyczy JPK_PKPIR</xsd:documentation> </xsd:annotation> </xsd:element> <xsd:element name="SumaPrzychodow" type="tns:TKwotowy"> <xsd:annotation> <xsd:documentation>Łączna wartość przychodów razem (kol. 9) w PKPIR w okresie, którego dotyczy JPK_PKPIR</xsd:documentation> </xsd:annotation> </xsd:element> </xsd:sequence> </xsd:complexType> </xsd:element></pre>

	<pre> </xsd:element> <xsd:element name="SumaPrzychodow" type="tns:TKwotowy"> <xsd:annotation> <xsd:documentation>Łączna wartość przychodów razem (kol. 9) w PKPIR w okresie, którego dotyczy JPK_PKPIR</xsd:documentation> </xsd:annotation> </xsd:element> </xsd:sequence> </xsd:complexType> </xsd:element> </pre>
--	--

element JPK/PKPIRCtrl/LiczbaWierszy

diagram													
namespace	http://jpk.mf.gov.pl/wzor/2016/10/26/10262/												
type	tns:TNaturalnyJPK												
properties	content simple												
facets	<table border="1"> <thead> <tr> <th>Kind</th> <th>Value</th> <th>Annotation</th> </tr> </thead> <tbody> <tr> <td>minExclusive</td> <td>0</td> <td></td> </tr> <tr> <td>totalDigits</td> <td>14</td> <td></td> </tr> <tr> <td>whiteSpace</td> <td>collapse</td> <td></td> </tr> </tbody> </table>	Kind	Value	Annotation	minExclusive	0		totalDigits	14		whiteSpace	collapse	
Kind	Value	Annotation											
minExclusive	0												
totalDigits	14												
whiteSpace	collapse												
annotation	documentation Liczba wierszy (zapisów) PKPIR, w okresie którego dotyczy JPK_PKPIR												
source	<pre> <xsd:element name="LiczbaWierszy" type="tns:TNaturalnyJPK"> <xsd:annotation> <xsd:documentation>Liczba wierszy (zapisów) PKPIR, w okresie którego dotyczy JPK_PKPIR</xsd:documentation> </xsd:annotation> </xsd:element> </pre>												

element JPK/PKPIRCtrl/SumaPrzychodow

diagram										
namespace	http://jpk.mf.gov.pl/wzor/2016/10/26/10262/									
type	tns:TKwotowy									
properties	content simple									
facets	<table border="1"> <thead> <tr> <th>Kind</th> <th>Value</th> <th>Annotation</th> </tr> </thead> <tbody> <tr> <td>totalDigits</td> <td>18</td> <td></td> </tr> <tr> <td>fractionDigits</td> <td>2</td> <td></td> </tr> </tbody> </table>	Kind	Value	Annotation	totalDigits	18		fractionDigits	2	
Kind	Value	Annotation								
totalDigits	18									
fractionDigits	2									

annotation	documentation Łączna wartość przychodów razem (kol. 9) w PKPIR w okresie, którego dotyczy JPK_PKPIR
source	<pre><xsd:element name="SumaPrzychodow" type="tns:TKwotowy"> <xsd:annotation> <xsd:documentation>Łączna wartość przychodów razem (kol. 9) w PKPIR w okresie, którego dotyczy JPK_PKPIR</xsd:documentation> </xsd:annotation> </xsd:element></pre>

complexType TAdresJPK

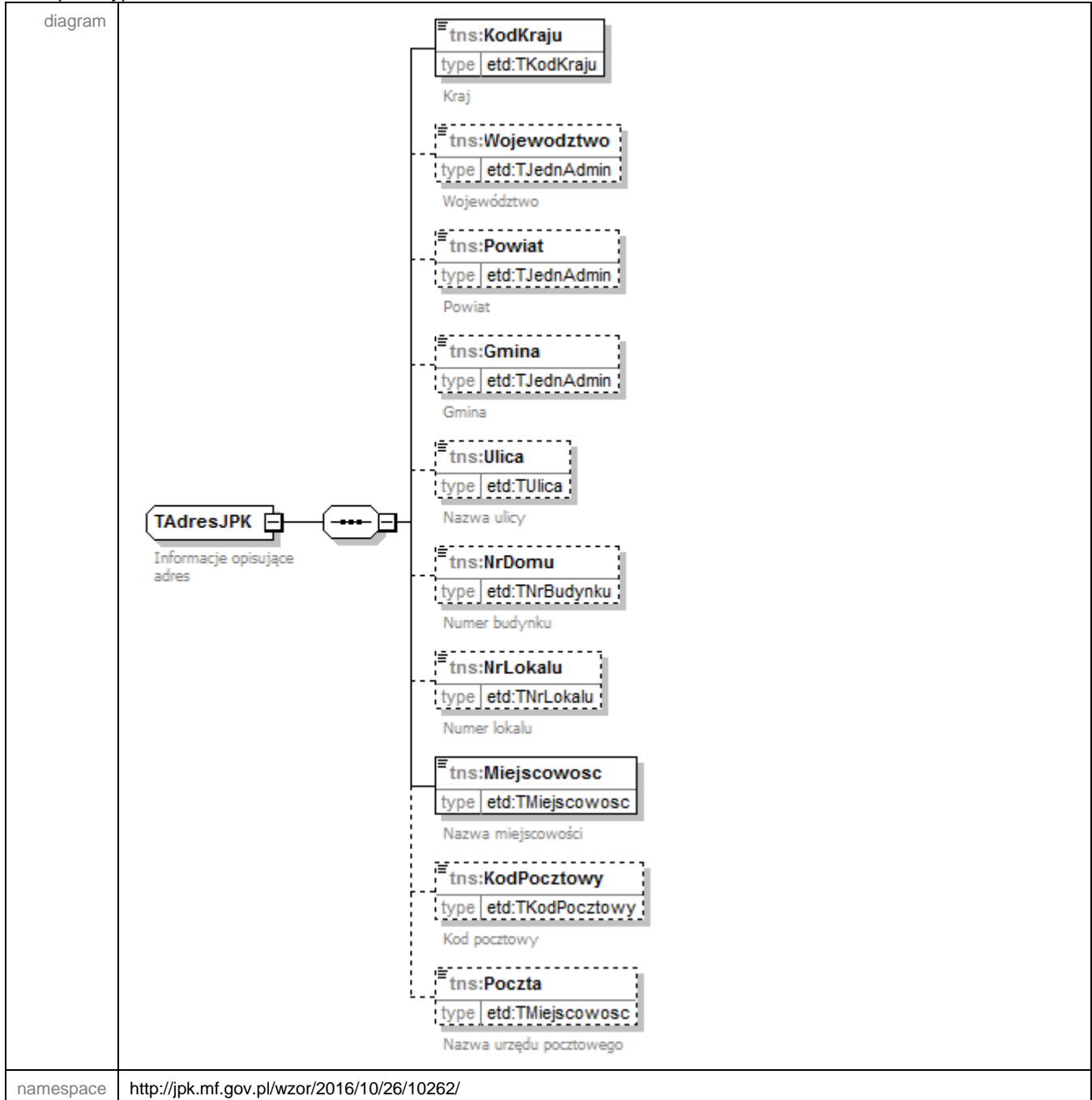

children	tns:KodKraju tns:Wojewodztwo tns:Powiat tns:Gmina tns:Ulica tns:NrDomu tns:NrLokalu tns:Miejscowosc tns:KodPocztowy tns:Poczta
used by	element JPK/Podmiot1/AdresPodmiotu
annotation	documentation Informacje opisujące adres
source	<pre> <xsd:complexType name="TAdresJPK"> <xsd:annotation> <xsd:documentation>Informacje opisujące adres</xsd:documentation> </xsd:annotation> <xsd:sequence> <xsd:element name="KodKraju" type="etd:TKodKraju"> <xsd:annotation> <xsd:documentation>Kraj</xsd:documentation> </xsd:annotation> </xsd:element> <xsd:element name="Wojewodztwo" type="etd:TJednAdmin" minOccurs="0"> <xsd:annotation> <xsd:documentation>Województwo</xsd:documentation> </xsd:annotation> </xsd:element> <xsd:element name="Powiat" type="etd:TJednAdmin" minOccurs="0"> <xsd:annotation> <xsd:documentation>Powiat</xsd:documentation> </xsd:annotation> </xsd:element> <xsd:element name="Gmina" type="etd:TJednAdmin" minOccurs="0"> <xsd:annotation> <xsd:documentation>Gmina</xsd:documentation> </xsd:annotation> </xsd:element> <xsd:element name="Ulica" type="etd:TUlica" minOccurs="0"> <xsd:annotation> <xsd:documentation>Nazwa ulicy</xsd:documentation> </xsd:annotation> </xsd:element> <xsd:element name="NrDomu" type="etd:TNrBudyunku" minOccurs="0"> <xsd:annotation> <xsd:documentation>Numer budynku</xsd:documentation> </xsd:annotation> </xsd:element> <xsd:element name="NrLokalu" type="etd:TNrLokalu" minOccurs="0"> <xsd:annotation> <xsd:documentation>Numer lokalu</xsd:documentation> </xsd:annotation> </xsd:element> <xsd:element name="Miejscowosc" type="etd:TMiejscowosc"> <xsd:annotation> <xsd:documentation>Nazwa miejscowości</xsd:documentation> </xsd:annotation> </xsd:element> <xsd:element name="KodPocztowy" type="etd:TKodPocztowy" minOccurs="0"> <xsd:annotation> <xsd:documentation>Kod pocztowy</xsd:documentation> </xsd:annotation> </xsd:element> </xsd:sequence> </xsd:complexType> </pre>

	<pre> <xsd:element name="Poczta" type="etd:TMiejscowosc" minOccurs="0"> <xsd:annotation> <xsd:documentation>Nazwa urzędu pocztowego</xsd:documentation> </xsd:annotation> </xsd:element> </xsd:sequence> </xsd:complexType> </pre>
--	--

element TAdresJPK/KodKraju

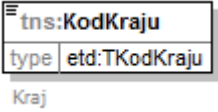
diagram	
namespace	http://jpk.mf.gov.pl/wzor/2016/10/26/10262/
type	etd:TKodKraju
properties	content simple
annotation	documentation Kraj
source	<pre> <xsd:element name="KodKraju" type="etd:TKodKraju"> <xsd:annotation> <xsd:documentation>Kraj</xsd:documentation> </xsd:annotation> </xsd:element> </pre>

element TAdresJPK/Wojewodztwo

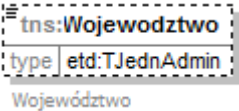
diagram	
namespace	http://jpk.mf.gov.pl/wzor/2016/10/26/10262/
type	etd:TJednAdmin
properties	minOcc 0 maxOcc 1 content simple
facets	Kind Value Annotation minLength 1 maxLength 36
annotation	documentation Województwo
source	<pre> <xsd:element name="Wojewodztwo" type="etd:TJednAdmin" minOccurs="0"> <xsd:annotation> <xsd:documentation>Województwo</xsd:documentation> </xsd:annotation> </xsd:element> </pre>

element TAdresJPK/Powiat

diagram										
namespace	http://jpk.mf.gov.pl/wzor/2016/10/26/10262/									
type	etd:TJednAdmin									
properties	minOcc 0 maxOcc 1 content simple									
facets	<table border="1"> <thead> <tr> <th>Kind</th> <th>Value</th> <th>Annotation</th> </tr> </thead> <tbody> <tr> <td>minLength</td> <td>1</td> <td></td> </tr> <tr> <td>maxLength</td> <td>36</td> <td></td> </tr> </tbody> </table>	Kind	Value	Annotation	minLength	1		maxLength	36	
Kind	Value	Annotation								
minLength	1									
maxLength	36									
annotation	documentation Powiat									
source	<pre><xsd:element name="Powiat" type="etd:TJednAdmin" minOccurs="0"> <xsd:annotation> <xsd:documentation>Powiat</xsd:documentation> </xsd:annotation> </xsd:element></pre>									

element TAdresJPK/Gmina

diagram										
namespace	http://jpk.mf.gov.pl/wzor/2016/10/26/10262/									
type	etd:TJednAdmin									
properties	minOcc 0 maxOcc 1 content simple									
facets	<table border="1"> <thead> <tr> <th>Kind</th> <th>Value</th> <th>Annotation</th> </tr> </thead> <tbody> <tr> <td>minLength</td> <td>1</td> <td></td> </tr> <tr> <td>maxLength</td> <td>36</td> <td></td> </tr> </tbody> </table>	Kind	Value	Annotation	minLength	1		maxLength	36	
Kind	Value	Annotation								
minLength	1									
maxLength	36									
annotation	documentation Gmina									
source	<pre><xsd:element name="Gmina" type="etd:TJednAdmin" minOccurs="0"> <xsd:annotation> <xsd:documentation>Gmina</xsd:documentation> </xsd:annotation> </xsd:element></pre>									

element TAdresJPK/Ulica

diagram	
namespace	http://jpk.mf.gov.pl/wzor/2016/10/26/10262/

type	etd:TUlica
properties	minOcc 0 maxOcc 1 content simple
facets	Kind Value Annotation minLength 1 maxLength 65
annotation	documentation Nazwa ulicy
source	<pre><xsd:element name="Ulica" type="etd:TUlica" minOccurs="0"> <xsd:annotation> <xsd:documentation>Nazwa ulicy</xsd:documentation> </xsd:annotation> </xsd:element></pre>

element TAdresJPK/NrDomu

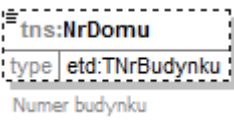
diagram	
namespace	http://jpk.mf.gov.pl/wzor/2016/10/26/10262/
type	etd:TNrBudytku
properties	minOcc 0 maxOcc 1 content simple
facets	Kind Value Annotation minLength 1 maxLength 9
annotation	documentation Numer budytku
source	<pre><xsd:element name="NrDomu" type="etd:TNrBudytku" minOccurs="0"> <xsd:annotation> <xsd:documentation>Numer budytku</xsd:documentation> </xsd:annotation> </xsd:element></pre>

element TAdresJPK/NrLokalu

diagram	
namespace	http://jpk.mf.gov.pl/wzor/2016/10/26/10262/
type	etd:TNrLokalu
properties	minOcc 0 maxOcc 1 content simple
facets	Kind Value Annotation minLength 1 maxLength 10

annotation	documentation Numer lokalu
source	<pre><xsd:element name="NrLokalu" type="etd:TNrLokalu" minOccurs="0"> <xsd:annotation> <xsd:documentation>Numer lokalu</xsd:documentation> </xsd:annotation> </xsd:element></pre>

element TAdresJPK/Miejscowosc

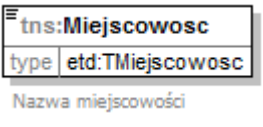
diagram										
namespace	http://jpk.mf.gov.pl/wzor/2016/10/26/10262/									
type	etd:TMiejscowosc									
properties	content simple									
facets	<table border="1"> <thead> <tr> <th>Kind</th> <th>Value</th> <th>Annotation</th> </tr> </thead> <tbody> <tr> <td>minLength</td> <td>1</td> <td></td> </tr> <tr> <td>maxLength</td> <td>56</td> <td></td> </tr> </tbody> </table>	Kind	Value	Annotation	minLength	1		maxLength	56	
Kind	Value	Annotation								
minLength	1									
maxLength	56									
annotation	documentation Nazwa miejscowości									
source	<pre><xsd:element name="Miejscowosc" type="etd:TMiejscowosc"> <xsd:annotation> <xsd:documentation>Nazwa miejscowości</xsd:documentation> </xsd:annotation> </xsd:element></pre>									

element TAdresJPK/KodPocztowy

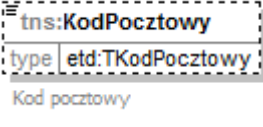
diagram										
namespace	http://jpk.mf.gov.pl/wzor/2016/10/26/10262/									
type	etd:TKodPocztowy									
properties	<table border="1"> <tbody> <tr> <td>minOcc</td> <td>0</td> </tr> <tr> <td>maxOcc</td> <td>1</td> </tr> <tr> <td>content</td> <td>simple</td> </tr> </tbody> </table>	minOcc	0	maxOcc	1	content	simple			
minOcc	0									
maxOcc	1									
content	simple									
facets	<table border="1"> <thead> <tr> <th>Kind</th> <th>Value</th> <th>Annotation</th> </tr> </thead> <tbody> <tr> <td>minLength</td> <td>1</td> <td></td> </tr> <tr> <td>maxLength</td> <td>8</td> <td></td> </tr> </tbody> </table>	Kind	Value	Annotation	minLength	1		maxLength	8	
Kind	Value	Annotation								
minLength	1									
maxLength	8									
annotation	documentation Kod pocztowy									
source	<pre><xsd:element name="KodPocztowy" type="etd:TKodPocztowy" minOccurs="0"> <xsd:annotation> <xsd:documentation>Kod pocztowy</xsd:documentation> </xsd:annotation> </xsd:element></pre>									

element **TAdresJPK/Poczta**

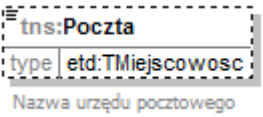
diagram	
namespace	http://jpk.mf.gov.pl/wzor/2016/10/26/10262/
type	etd:TMiejscowosc
properties	minOcc 0 maxOcc 1 content simple
facets	Kind Value Annotation minLength 1 maxLength 56
annotation	documentation Nazwa urzędu pocztowego
source	<pre> <xsd:element name="Poczta" type="etd:TMiejscowosc" minOccurs="0"> <xsd:annotation> <xsd:documentation>Nazwa urzędu pocztowego</xsd:documentation> </xsd:annotation> </xsd:element> </pre>

complexType TNaglowek

<p>diagram</p>	
<p>namespace</p>	<p>http://jpk.mf.gov.pl/wzor/2016/10/26/10262/</p>
<p>children</p>	<p>tns:KodFormularza tns:WariantFormularza tns:CelZlozenia tns:DataWytworzeniaJPK tns:DataOd tns:DataDo tns:DomyslnyKodWaluty tns:KodUrzedu</p>
<p>used by</p>	<p>element JPK/Naglowek</p>
<p>annotation</p>	<p>documentation Nagłówek JPK_PKPIR</p>
<p>source</p>	<pre><xsd:complexType name="TNaglowek"> <xsd:annotation> <xsd:documentation>Nagłówek JPK_PKPIR</xsd:documentation> </xsd:annotation> <xsd:sequence> <xsd:element name="KodFormularza"> <xsd:complexType> <xsd:simpleContent> <xsd:extension base="tns:TKodFormularza"> <xsd:attribute name="kodSystemowy" type="xsd:string" use="required" fixed="JPK_PKPIR (2)"/> <xsd:attribute name="wersjaSchemy" type="xsd:string" use="required" fixed="1-0"/> </xsd:extension> </xsd:simpleContent> </xsd:complexType> </xsd:element> </xsd:sequence> </xsd:complexType></pre>

```

</xsd:extension>
</xsd:simpleContent>
</xsd:complexType>
</xsd:element>
<xsd:element name="WariantFormularza">
  <xsd:simpleType>
    <xsd:restriction base="xsd:byte">
      <xsd:enumeration value="2"/>
    </xsd:restriction>
  </xsd:simpleType>
</xsd:element>
<xsd:element name="CelZlozenia" type="tns:TCelZlozenia"/>
<xsd:element name="DataWytworzeniaJPK" type="etd:TDataCzas">
  <xsd:annotation>
    <xsd:documentation>Data i czas wytworzenia JPK_PKPIR</xsd:documentation>
  </xsd:annotation>
</xsd:element>
<xsd:element name="DataOd" type="etd:TData">
  <xsd:annotation>
    <xsd:documentation>Data początkowa okresu, którego dotyczy
JPK_PKPIR</xsd:documentation>
  </xsd:annotation>
</xsd:element>
<xsd:element name="DataDo" type="etd:TData">
  <xsd:annotation>
    <xsd:documentation>Data końcowa okresu, którego dotyczy
JPK_PKPIR</xsd:documentation>
  </xsd:annotation>
</xsd:element>
<xsd:element name="DomyslnyKodWaluty" type="kck:currCode_Type">
  <xsd:annotation>
    <xsd:documentation>Trzyliterowy kod lokalnej waluty (ISO-4217), domyślny dla
wytworzonego JPK_PKPIR</xsd:documentation>
  </xsd:annotation>
</xsd:element>
<xsd:element name="KodUrzedu" type="etd:TKodUS"/>
</xsd:sequence>
</xsd:complexType>

```

element **TNaglowek/KodFormularza**

diagram	<pre> classDiagram class tnsTKodFormularza { } class tnsKodFormularza { } tnsTKodFormularza < -- tnsKodFormularza class attributes { } tnsKodFormularza --> attributes : kodSystemowy tnsKodFormularza --> attributes : wersjaSchemy </pre>					
namespace	http://jpk.mf.gov.pl/wzor/2016/10/26/10262/					
type	extension of tns:TKodFormularza					
properties	content complex					
attributes	Name	Type	Use	Default	Fixed	Annotation
	kodSystemowy	xsd:string	required		JPK_PKPIR (2)	

	wersjaSchemy xsd:string required 1-0
source	<pre> <xsd:element name="KodFormularza"> <xsd:complexType> <xsd:simpleContent> <xsd:extension base="tns:TKodFormularza"> <xsd:attribute name="kodSystemowy" type="xsd:string" use="required" fixed="JPK_PKPIR (2)"/> <xsd:attribute name="wersjaSchemy" type="xsd:string" use="required" fixed="1-0"/> </xsd:extension> </xsd:simpleContent> </xsd:complexType> </xsd:element> </pre>

attribute TNaglowek/KodFormularza/@kodSystemowy

type	xsd:string				
properties	<table> <tr> <td>use</td> <td>required</td> </tr> <tr> <td>fixed</td> <td>JPK_PKPIR (2)</td> </tr> </table>	use	required	fixed	JPK_PKPIR (2)
use	required				
fixed	JPK_PKPIR (2)				
source	<pre><xsd:attribute name="kodSystemowy" type="xsd:string" use="required" fixed="JPK_PKPIR (2)"/></pre>				

attribute TNaglowek/KodFormularza/@wersjaSchemy

type	xsd:string				
properties	<table> <tr> <td>use</td> <td>required</td> </tr> <tr> <td>fixed</td> <td>1-0</td> </tr> </table>	use	required	fixed	1-0
use	required				
fixed	1-0				
source	<pre><xsd:attribute name="wersjaSchemy" type="xsd:string" use="required" fixed="1-0"/></pre>				

element TNaglowek/WariantFormularza

diagram	<pre> tns:WariantFormularza type xsd:byte </pre>
namespace	http://jpk.mf.gov.pl/wzor/2016/10/26/10262/
type	restriction of xsd:byte
properties	content simple
source	<pre> <xsd:element name="WariantFormularza"> <xsd:simpleType> <xsd:restriction base="xsd:byte"> <xsd:enumeration value="2"/> </xsd:restriction> </xsd:simpleType> </xsd:element> </pre>

element TNaglowek/CelZlozenia

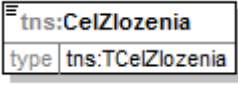
diagram	
namespace	http://jpk.mf.gov.pl/wzor/2016/10/26/10262/
type	tns:TCeZlozenia
properties	content simple
source	<code><xsd:element name="CeZlozenia" type="tns:TCeZlozenia"/></code>

element TNaglowek/DataWytworzeniaJPK

diagram							
namespace	http://jpk.mf.gov.pl/wzor/2016/10/26/10262/						
type	etd:TDataCzas						
properties	content simple						
facets	<table border="1"> <thead> <tr> <th>Kind</th> <th>Value</th> <th>Annotation</th> </tr> </thead> <tbody> <tr> <td>whiteSpace</td> <td>collapse</td> <td></td> </tr> </tbody> </table>	Kind	Value	Annotation	whiteSpace	collapse	
Kind	Value	Annotation					
whiteSpace	collapse						
annotation	documentation Data i czas wytworzenia JPK_PKPIR						
source	<code><xsd:element name="DataWytworzeniaJPK" type="etd:TDataCzas"> <xsd:annotation> <xsd:documentation>Data i czas wytworzenia JPK_PKPIR</xsd:documentation> </xsd:annotation> </xsd:element></code>						

element TNaglowek/DataOd

diagram													
namespace	http://jpk.mf.gov.pl/wzor/2016/10/26/10262/												
type	etd:TData												
properties	content simple												
facets	<table border="1"> <thead> <tr> <th>Kind</th> <th>Value</th> <th>Annotation</th> </tr> </thead> <tbody> <tr> <td>minInclusive</td> <td>1900-01-01</td> <td></td> </tr> <tr> <td>maxInclusive</td> <td>2030-12-31</td> <td></td> </tr> <tr> <td>pattern</td> <td>((\d{4})-(\d{2})-(\d{2}))</td> <td></td> </tr> </tbody> </table>	Kind	Value	Annotation	minInclusive	1900-01-01		maxInclusive	2030-12-31		pattern	((\d{4})-(\d{2})-(\d{2}))	
Kind	Value	Annotation											
minInclusive	1900-01-01												
maxInclusive	2030-12-31												
pattern	((\d{4})-(\d{2})-(\d{2}))												
annotation	documentation Data początkowa okresu, którego dotyczy JPK_PKPIR												
source	<code><xsd:element name="DataOd" type="etd:TData"></code>												

	<pre> <xsd:annotation> <xsd:documentation>Data początkowa okresu, którego dotyczy JPK_PKPIR</xsd:documentation> </xsd:annotation> </xsd:element> </pre>
--	---

element TNaglowek/DataDo

diagram													
namespace	http://jpk.mf.gov.pl/wzor/2016/10/26/10262/												
type	etd:TData												
properties	content simple												
facets	<table border="1"> <thead> <tr> <th>Kind</th> <th>Value</th> <th>Annotation</th> </tr> </thead> <tbody> <tr> <td>minInclusive</td> <td>1900-01-01</td> <td></td> </tr> <tr> <td>maxInclusive</td> <td>2030-12-31</td> <td></td> </tr> <tr> <td>pattern</td> <td>((\d{4})-(\d{2})-(\d{2}))</td> <td></td> </tr> </tbody> </table>	Kind	Value	Annotation	minInclusive	1900-01-01		maxInclusive	2030-12-31		pattern	((\d{4})-(\d{2})-(\d{2}))	
Kind	Value	Annotation											
minInclusive	1900-01-01												
maxInclusive	2030-12-31												
pattern	((\d{4})-(\d{2})-(\d{2}))												
annotation	documentation Data końcowa okresu, którego dotyczy JPK_PKPIR												
source	<pre> <xsd:element name="DataDo" type="etd:TData"> <xsd:annotation> <xsd:documentation>Data końcowa okresu, którego dotyczy JPK_PKPIR</xsd:documentation> </xsd:annotation> </xsd:element> </pre>												

element TNaglowek/DomyslnyKodWaluty

diagram	
namespace	http://jpk.mf.gov.pl/wzor/2016/10/26/10262/
type	kck:currCode_Type
properties	content simple
annotation	documentation Trzyliterowy kod lokalnej waluty (ISO-4217), domyślny dla wytworzonego JPK_PKPIR
source	<pre> <xsd:element name="DomyslnyKodWaluty" type="kck:currCode_Type"> <xsd:annotation> <xsd:documentation>Trzyliterowy kod lokalnej waluty (ISO-4217), domyślny dla wytworzonego JPK_PKPIR</xsd:documentation> </xsd:annotation> </xsd:element> </pre>

element TNaglowek/KodUrzedu

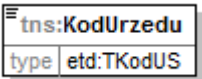
diagram	
namespace	http://jpk.mf.gov.pl/wzor/2016/10/26/10262/
type	etd:TKodUS
properties	content simple
source	<xsd:element name="KodUrzedu" type="etd:TKodUS"/>

simpleType TCelZlozenia

namespace	http://jpk.mf.gov.pl/wzor/2016/10/26/10262/
type	restriction of xsd:byte
properties	base xsd:byte
used by	element TNaglowek/CelZlozenia
annotation	documentation Określenie celu złożenia JPK
source	<pre><xsd:simpleType name="TCelZlozenia"> <xsd:annotation> <xsd:documentation>Określenie celu złożenia JPK</xsd:documentation> </xsd:annotation> <xsd:restriction base="xsd:byte"> <xsd:enumeration value="1"> <xsd:annotation> <xsd:documentation>złożenie JPK po raz pierwszy</xsd:documentation> </xsd:annotation> </xsd:enumeration> </xsd:restriction> </xsd:simpleType></pre>

simpleType TKodFormularza

namespace	http://jpk.mf.gov.pl/wzor/2016/10/26/10262/
type	restriction of xsd:string
properties	base xsd:string
used by	element TNaglowek/KodFormularza
annotation	documentation Symbol wzoru formularza
source	<pre><xsd:simpleType name="TKodFormularza"> <xsd:annotation> <xsd:documentation>Symbol wzoru formularza</xsd:documentation> </xsd:annotation> <xsd:restriction base="xsd:string"> <xsd:enumeration value="JPK_PKPIR"/> </xsd:restriction> </xsd:simpleType></pre>

simpleType TKwotowy

namespace	http://jpk.mf.gov.pl/wzor/2016/10/26/10262/		
type	restriction of xsd:decimal		
properties	base xsd:decimal		
used by	elements	JPK/PKPIRWiersz/K 10 JPK/PKPIRWiersz/K 11 JPK/PKPIRWiersz/K 12 JPK/PKPIRWiersz/K 13 JPK/PKPIRWiersz/K 14 JPK/PKPIRWiersz/K 15 JPK/PKPIRWiersz/K 16B JPK/PKPIRWiersz/K 7 JPK/PKPIRWiersz/K 8 JPK/PKPIRWiersz/K 9 JPK/PKPIRInfo/P 1 JPK/PKPIRInfo/P 2 JPK/PKPIRInfo/P 3 JPK/PKPIRInfo/P 4 JPK/PKPIRSpis/P 5B JPK/PKPIRCtrl/SumaPrzychodow	
facets	Kind	Value	Annotation
	totalDigits	18	
	fractionDigits	2	
annotation	documentation Wartość numeryczna 18 znaków max, w tym 2 znaki po przecinku		
source	<pre><xsd:simpleType name="TKwotowy"> <xsd:annotation> <xsd:documentation>Wartość numeryczna 18 znaków max, w tym 2 znaki po przecinku</xsd:documentation> </xsd:annotation> <xsd:restriction base="xsd:decimal"> <xsd:totalDigits value="18"/> <xsd:fractionDigits value="2"/> </xsd:restriction> </xsd:simpleType></pre>		

simpleType TNaturalnyJPK

namespace	http://jpk.mf.gov.pl/wzor/2016/10/26/10262/		
type	restriction of etd:TNaturalny		
properties	base etd:TNaturalny		
used by	elements	JPK/PKPIRWiersz/K 1 JPK/PKPIRCtrl/LiczbaWierszy	
facets	Kind	Value	Annotation
	minExclusive	0	
	totalDigits	14	
	whiteSpace	collapse	
annotation	documentation Liczby naturalne większe od zera		
source	<pre><xsd:simpleType name="TNaturalnyJPK"> <xsd:annotation> <xsd:documentation>Liczby naturalne większe od zera</xsd:documentation> </xsd:annotation> <xsd:restriction base="etd:TNaturalny"> <xsd:minExclusive value="0"/> </xsd:restriction> </xsd:simpleType></pre>		

simpleType TZnakowyJPK

namespace	http://jpk.mf.gov.pl/wzor/2016/10/26/10262/		
-----------	---	--	--

type	restriction of xsd:token									
properties	base xsd:token									
used by	elements JPK/PKPIRWiersz/K 16A JPK/PKPIRWiersz/K 17 JPK/PKPIRWiersz/K 3 JPK/PKPIRWiersz/K 4 JPK/PKPIRWiersz/K 5 JPK/PKPIRWiersz/K 6									
facets	<table border="1"> <thead> <tr> <th>Kind</th> <th>Value</th> <th>Annotation</th> </tr> </thead> <tbody> <tr> <td>minLength</td> <td>1</td> <td></td> </tr> <tr> <td>maxLength</td> <td>256</td> <td></td> </tr> </tbody> </table>	Kind	Value	Annotation	minLength	1		maxLength	256	
Kind	Value	Annotation								
minLength	1									
maxLength	256									
annotation	documentation Typ znakowy ograniczony do 256 znaków									
source	<pre> <xsd:simpleType name="TZnakowyJPK"> <xsd:annotation> <xsd:documentation>Typ znakowy ograniczony do 256 znaków</xsd:documentation> </xsd:annotation> <xsd:restriction base="xsd:token"> <xsd:minLength value="1"/> <xsd:maxLength value="256"/> </xsd:restriction> </xsd:simpleType> </pre>									